



 **Gesab**<sup>®</sup>  
guarantee for the future



**advantis**  
NEW GENERATION



## Character >

Pure lines. Vectors of beauty that come together to define a single architecture. Molecules floating in formal harmony. A new generation of organic minimalism.





## Innovation >

The perfect machine: power and control. Softness and firmness. Technology at the service of the imagination. Creativity for an efficient and safe environment.



# Personality >

Designed by people for people.  
Sensory, emotional, intense.  
An experience with identity.



# Design >

A line suggests an idea. A stroke conceives a way of seeing the world.  
The ADVANTIS NG concept is a philosophy of life, an attitude towards the challenges.





# take control

## Take control >

Take the course, be in control. The future as destination and origin of the same trip. Technology and design that challenge the test of time.







**advantis**  
NEW GENERATION

## The system >

*"Everything a person can imagine,  
others can make it happen"*



Jules Verne

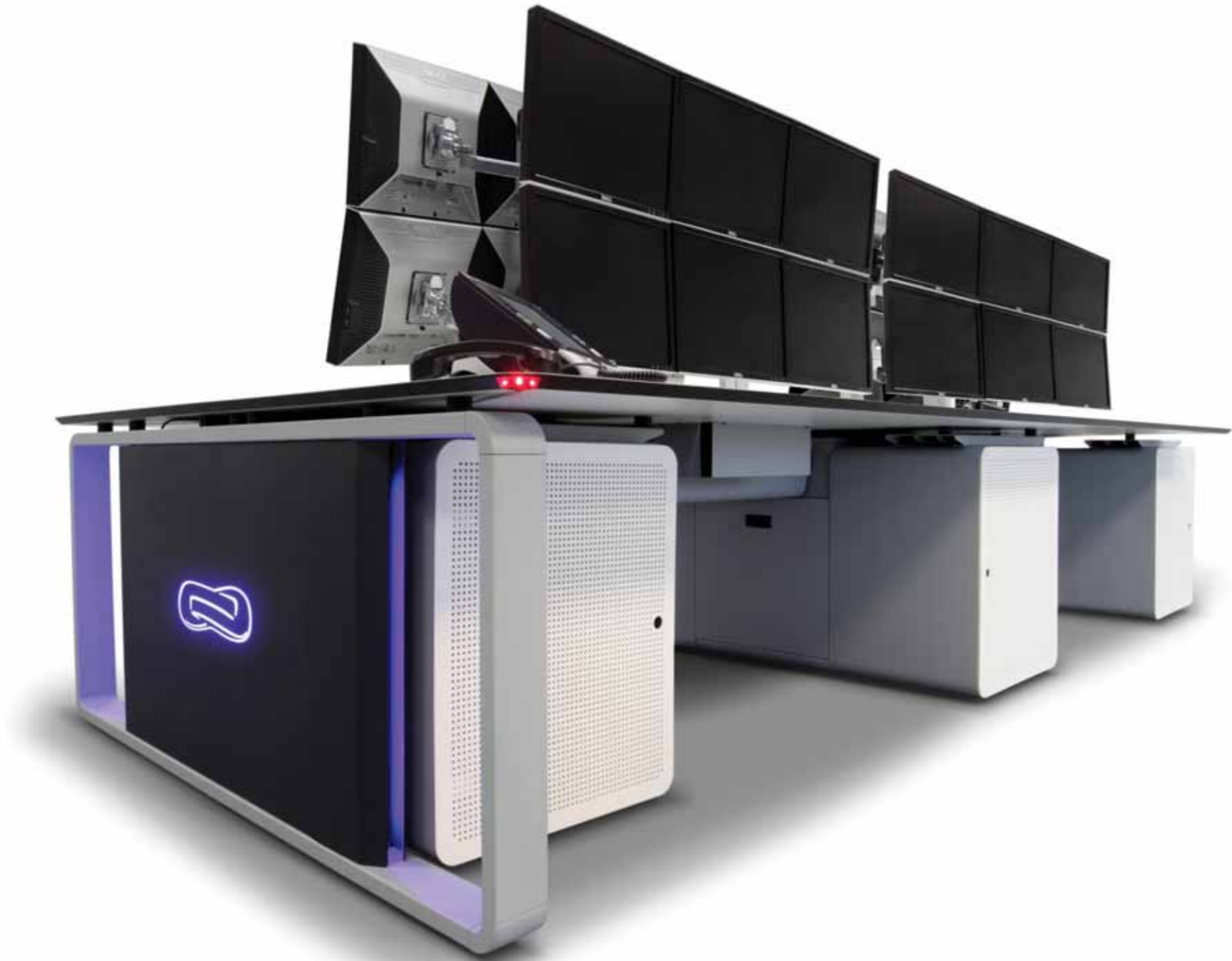

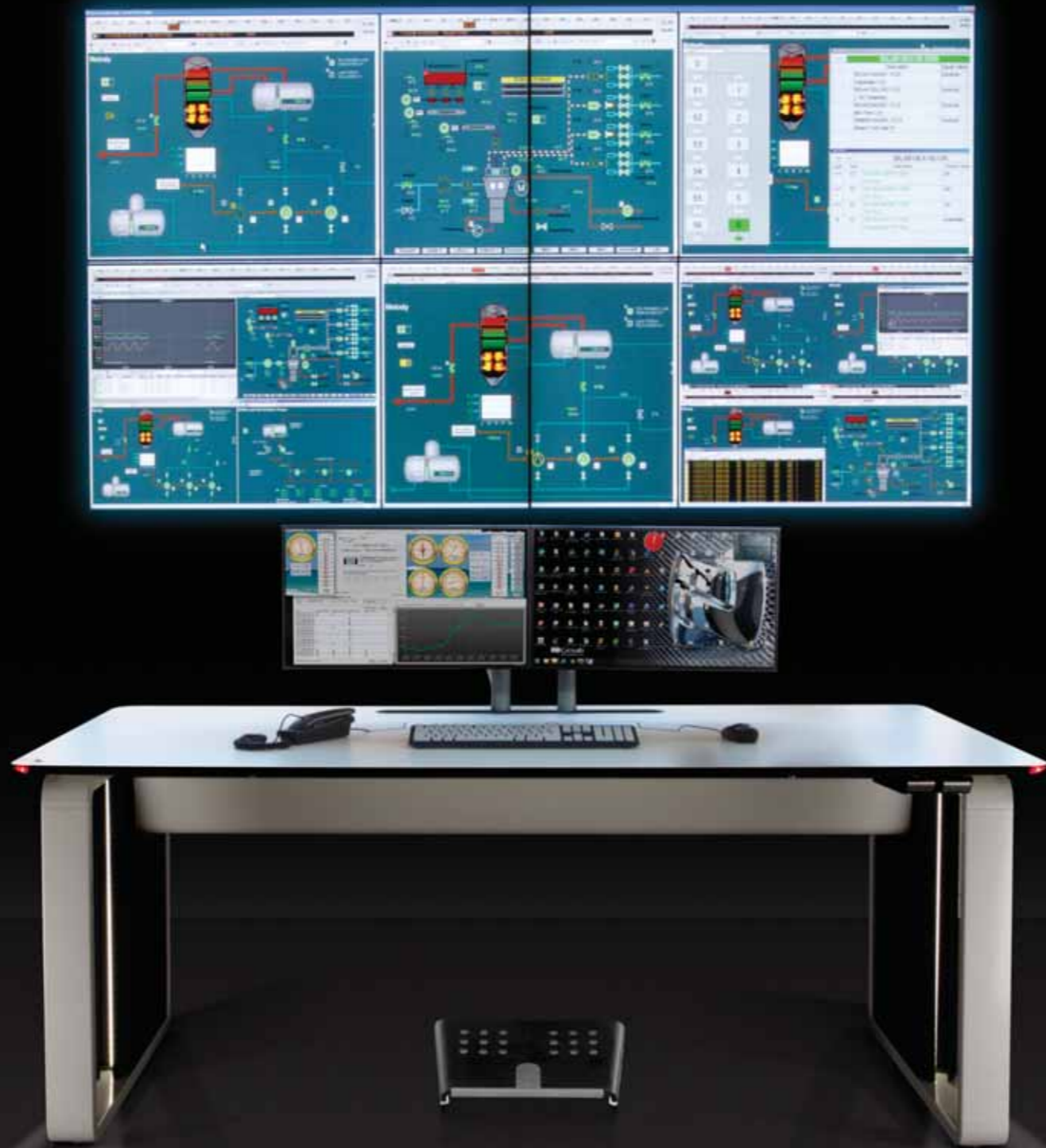



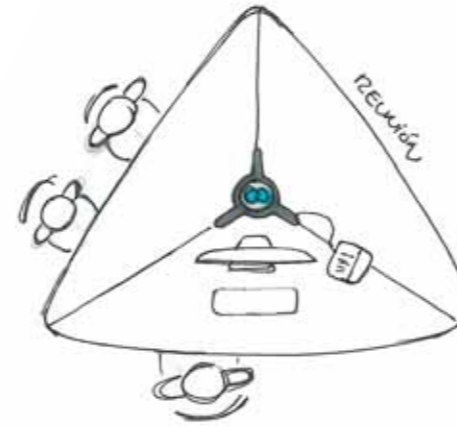

# A global concept >

*"Practice should always be built on good theory"*



Leonardo da Vinci

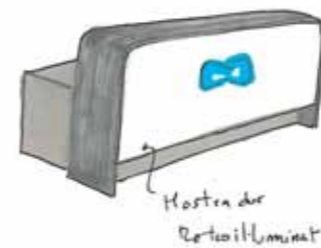
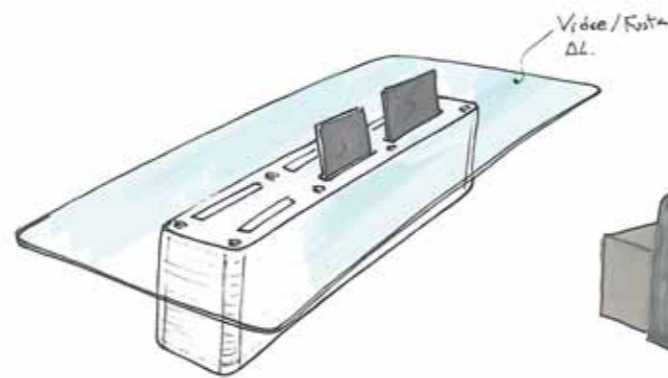
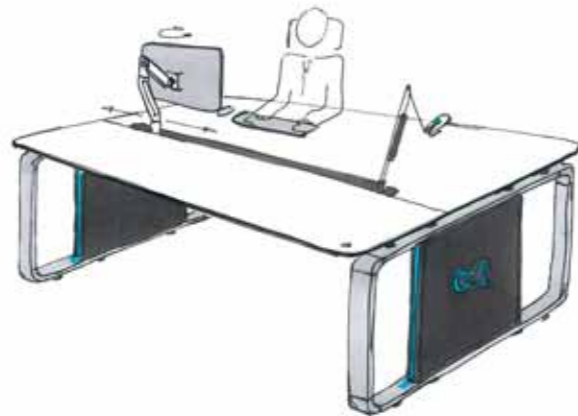
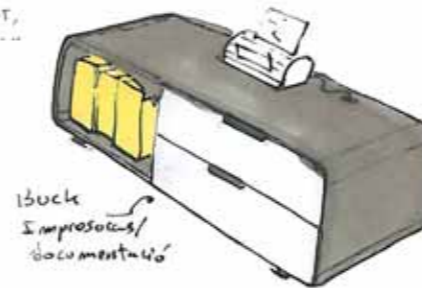
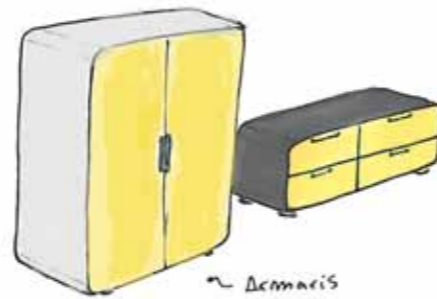

# Beyond Technology



-  SPINAL BEAM
-  NEXUS GATE
-  FLOATING WORK SURFACE
-  VISUAL ERGONOMICS
-  SAFETY
-  PERSONAL DOCK
-  i-BOX
-  TECHNICAL BUCK



## Spinal beam >

It is the backbone of the system. It fixes the structure and leads and distributes power and data cabling. Its amplitude can house inside KVM, thin client computers or any other kind of electronic equipment.

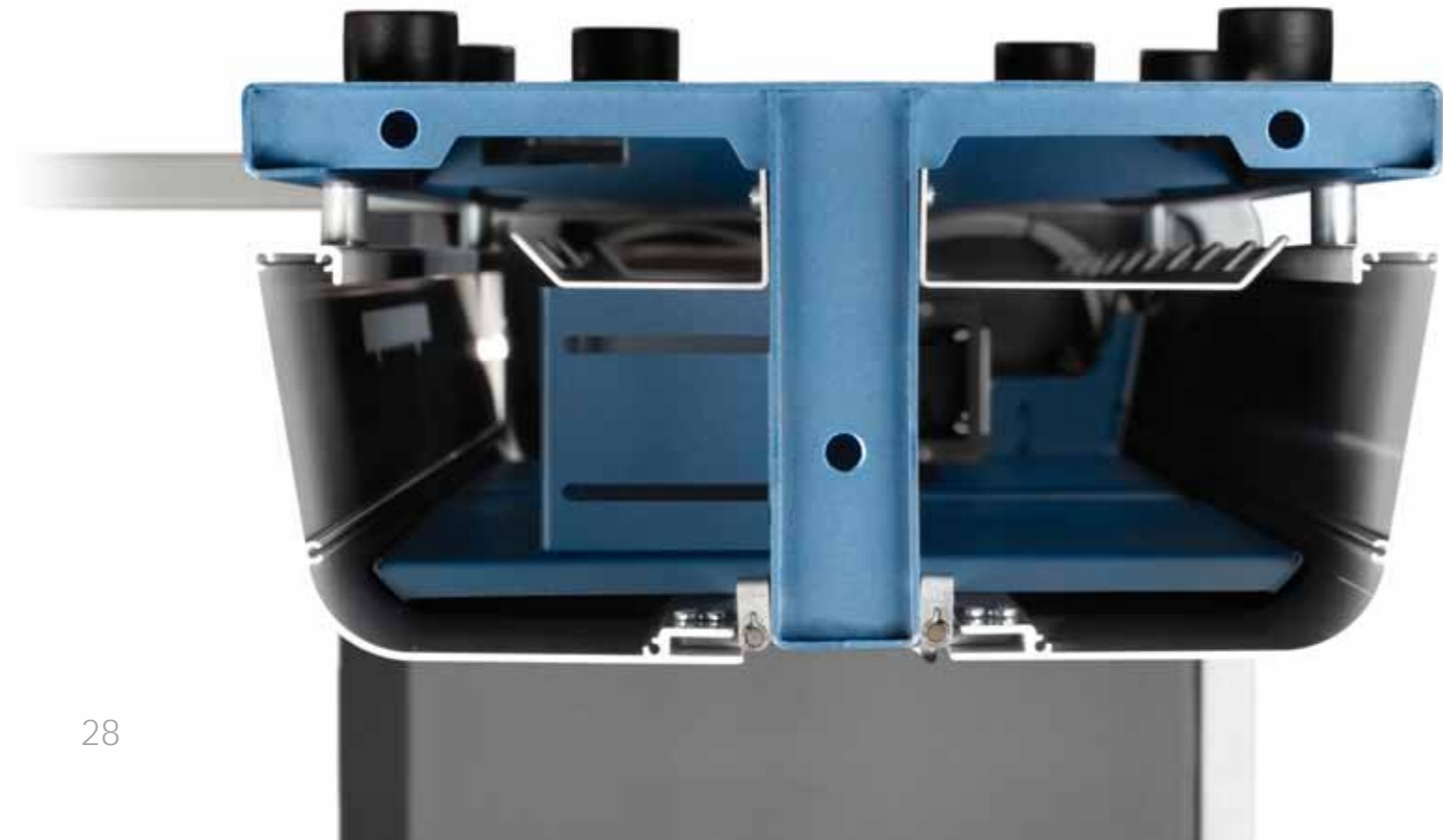



## Nexus Gate >

The ADVANTIS New Generation system favors maximum connectivity with an optimal wiring organization.

Its modular design adapts to all requirements and configurations of 24x7x365 operating environments.

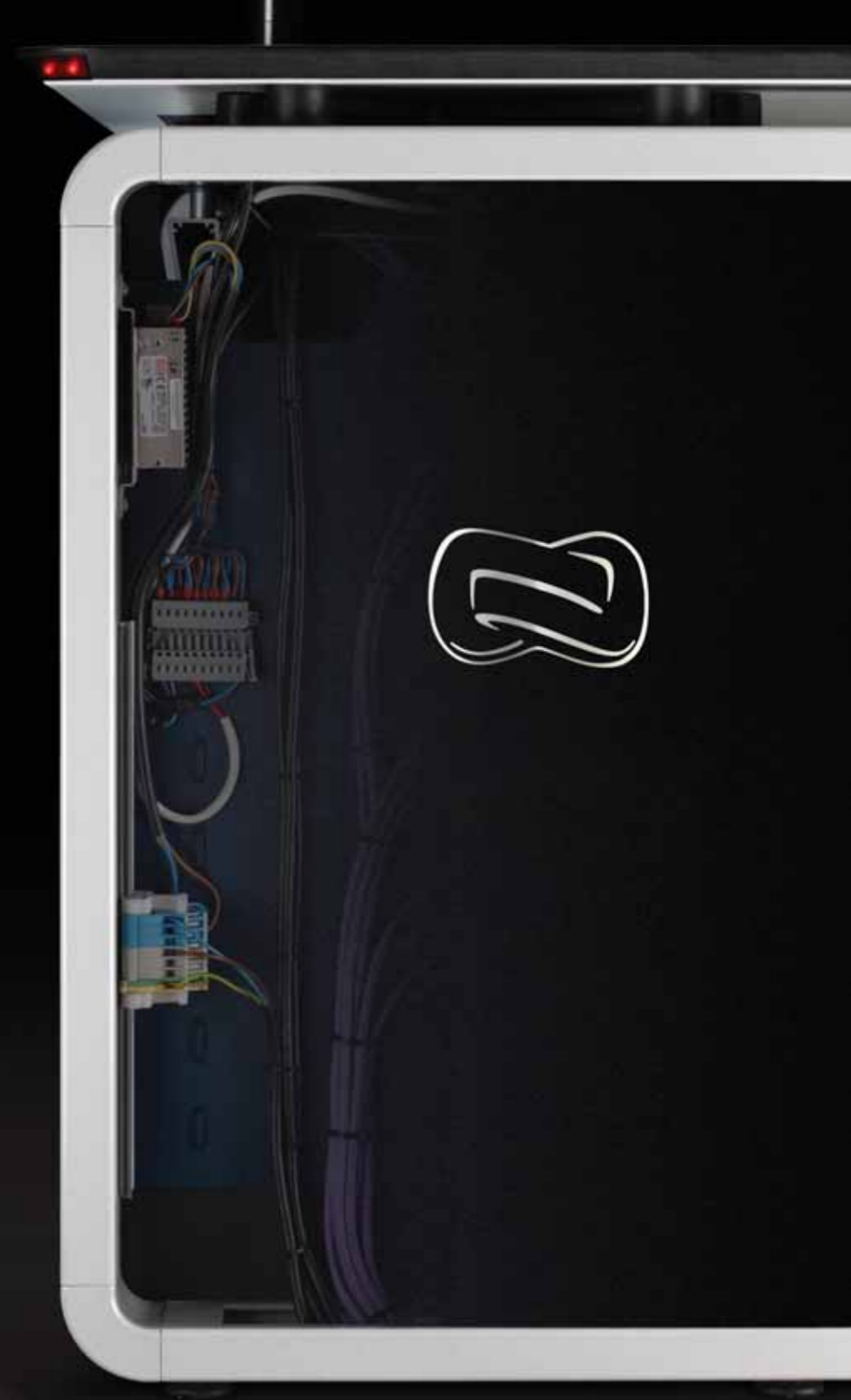





## Floating Work Surface >

In a place of high demand, the ADVANTIS New Generation console isolates the operator in a safe and healthy environment, free from vibration, thanks to the floating work plane.





## Visual Ergonomics >

The new and exclusive arms systems put cables away from the operator, hide them from view, leaving the operational area free.

They fit all viewing needs and enhance the work with 4 dimensions ergonomics.





## Safety >

A unique integrated illumination system with LED beacons designed to meet safety and functionality requirements.

In any situation, everything remains under control.





## Personal Dock >

A space for personal effects and operator connectivity.  
Comfortable, flexible. Everything at hand, without leaving the control task.





## i-Box >

All the details are important. I-Box is a space designed for the comfort of people. This is a single container with the perfect size for documents and personal belongings.

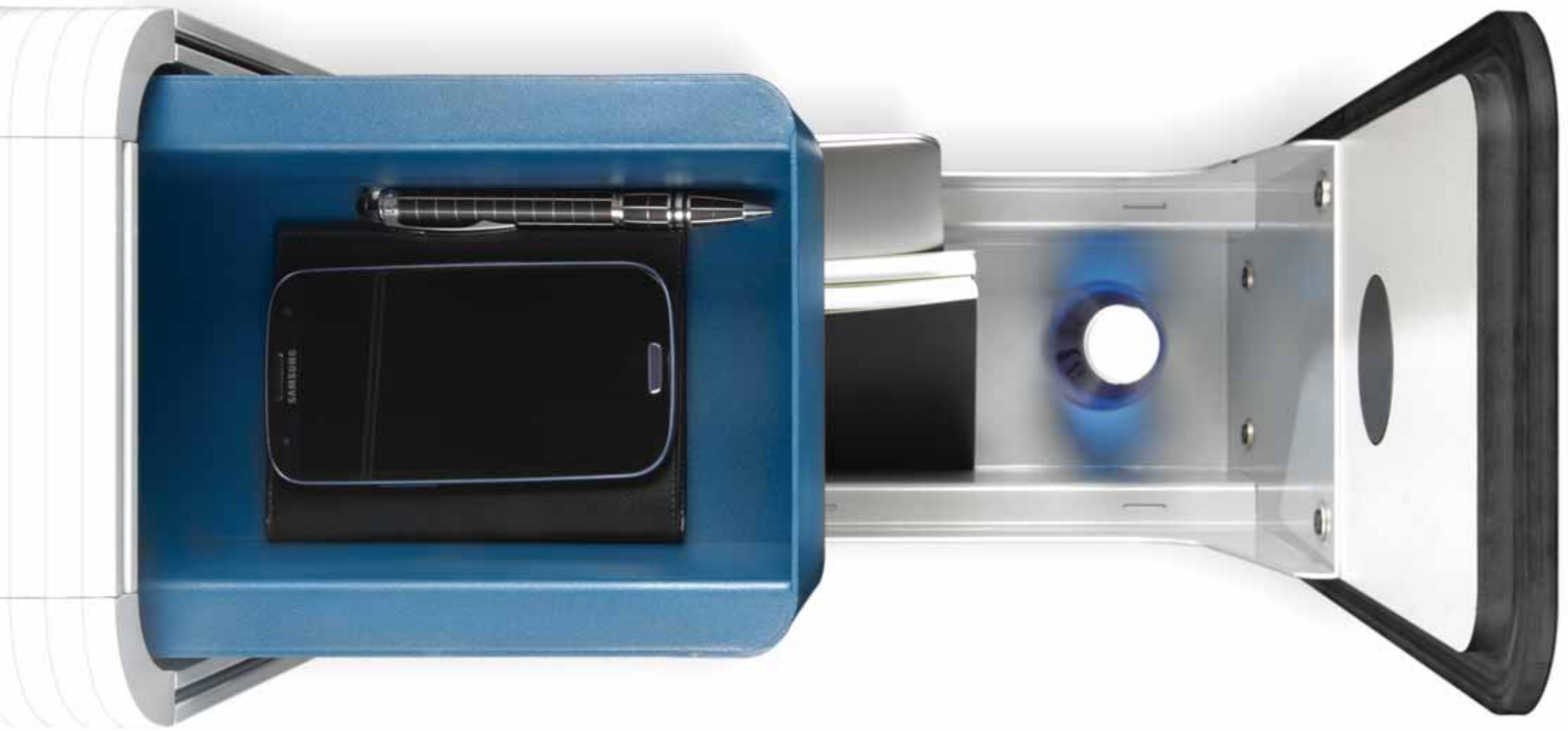

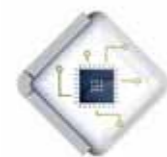

## Technical Buck >

For the most demanding environments in terms of technical equipment, ADVANTIS New Generation has a wide range of bucks that are integrated as never before in the very structure of the console to ensure direct communication with the rest of the console sectors and facilitate their integration.









## Connectivity >

An infinite universe that comes together; it connects. Bidirectional pulses travel through the system to keep the information moving 24 hours a day. 365 days a year.





## Smart KVM >

Intelligent professional connectivity. No matter the distance or the difficulty of the task. ADVANTIS NG is ready for total control.





# Human Factor >

Health, comfort and productivity. These are the three factors that, in that order, guide our designers.

GESAB'S ADVANTIS NG has been created fulfilling the UNE-EN 527-2011, ISO 11064-3 and NTP602.

"The action creates the form" is our philosophy in design: we provide solutions that are tailored to the working postures of the operator.

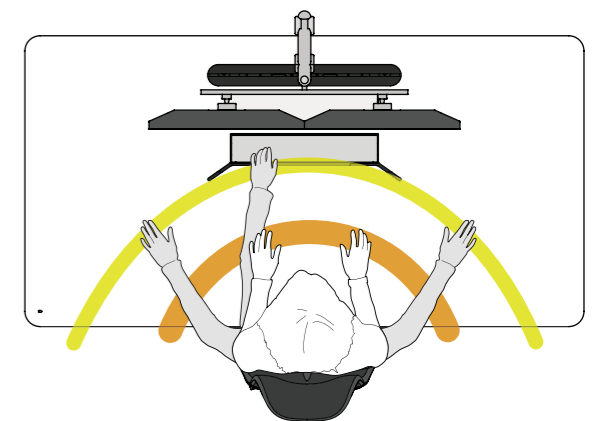
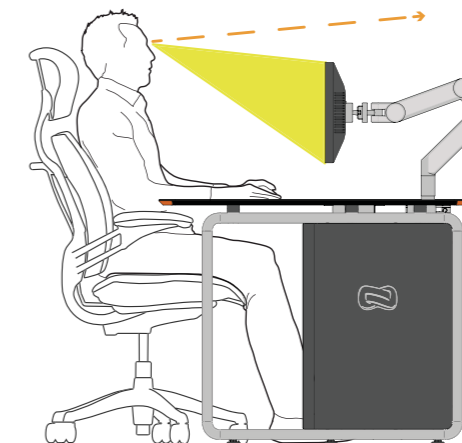
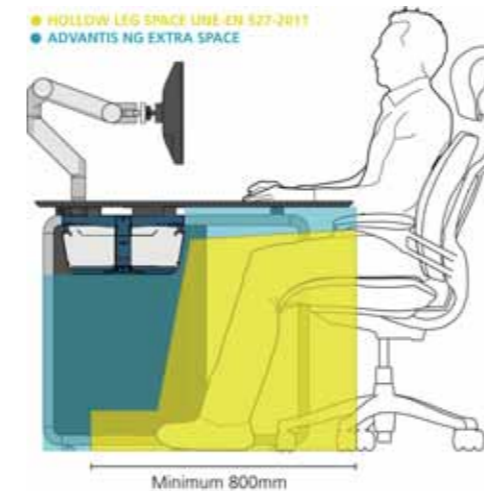
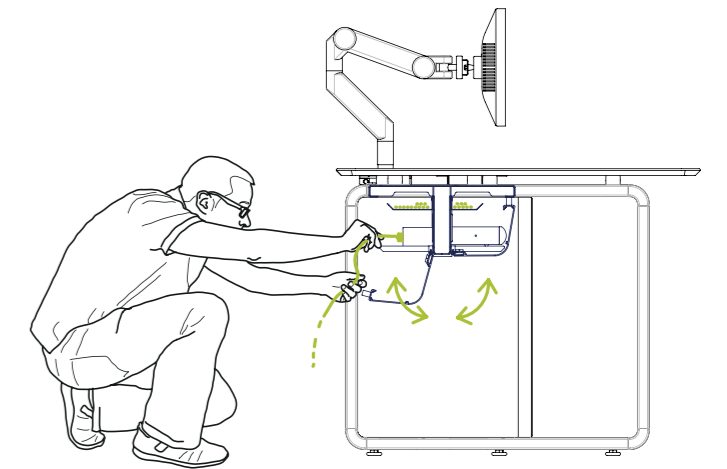

# Ecology >

GESAB designs its products and solutions with global, sustainable and future mindset. We design, manufacture and assemble with the awareness that the planet's resources are limited. So an ADVANTIS NG is highly made of recyclable materials that guarantee long life to the product.

Such selective recycling process begins at the moment of its removal, after its useful life.



# Finishes >

The finishes are an intrinsic part of the product.

For this reason GESAB has defined optimal colors and finishes for ADVANTIS NG that we recommend to apply, both for aesthetical and functionality reasons. DeepBlue NG is the color that guides the cable management, the nuclear part of the system.

## advantis NEW GENERATION STANDARD METALLIC COLORS



DeepBlue NG



Anthracite



Metallic gray

## FUNDERMAX

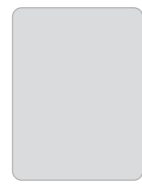

# Efficiency and effectiveness >

Instinct environmental protection for maximum performance. The greatest result with the least impact. The highest power with the lowest cost. ADVANTIS NG optimizes resources with an excellent result.

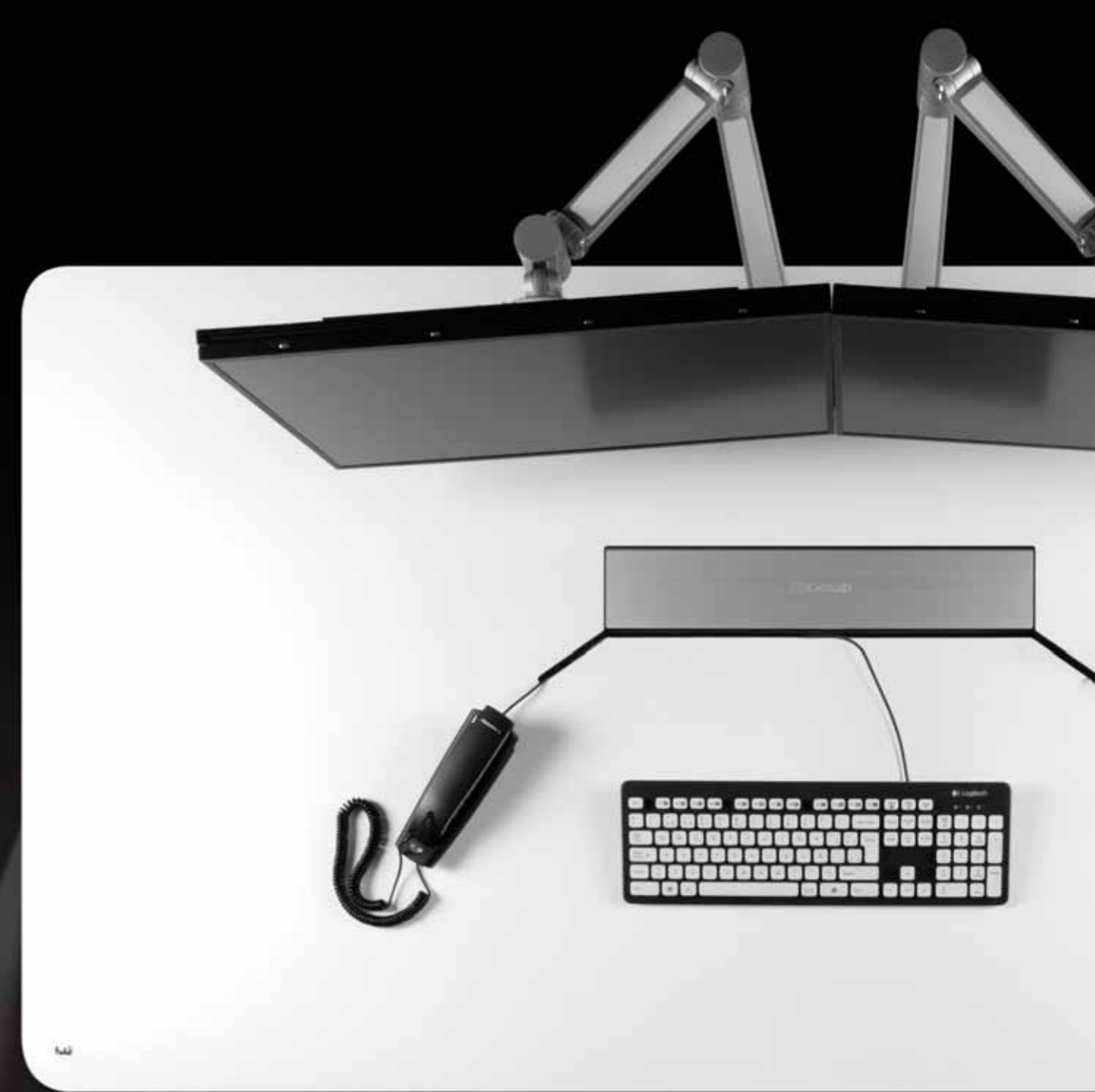
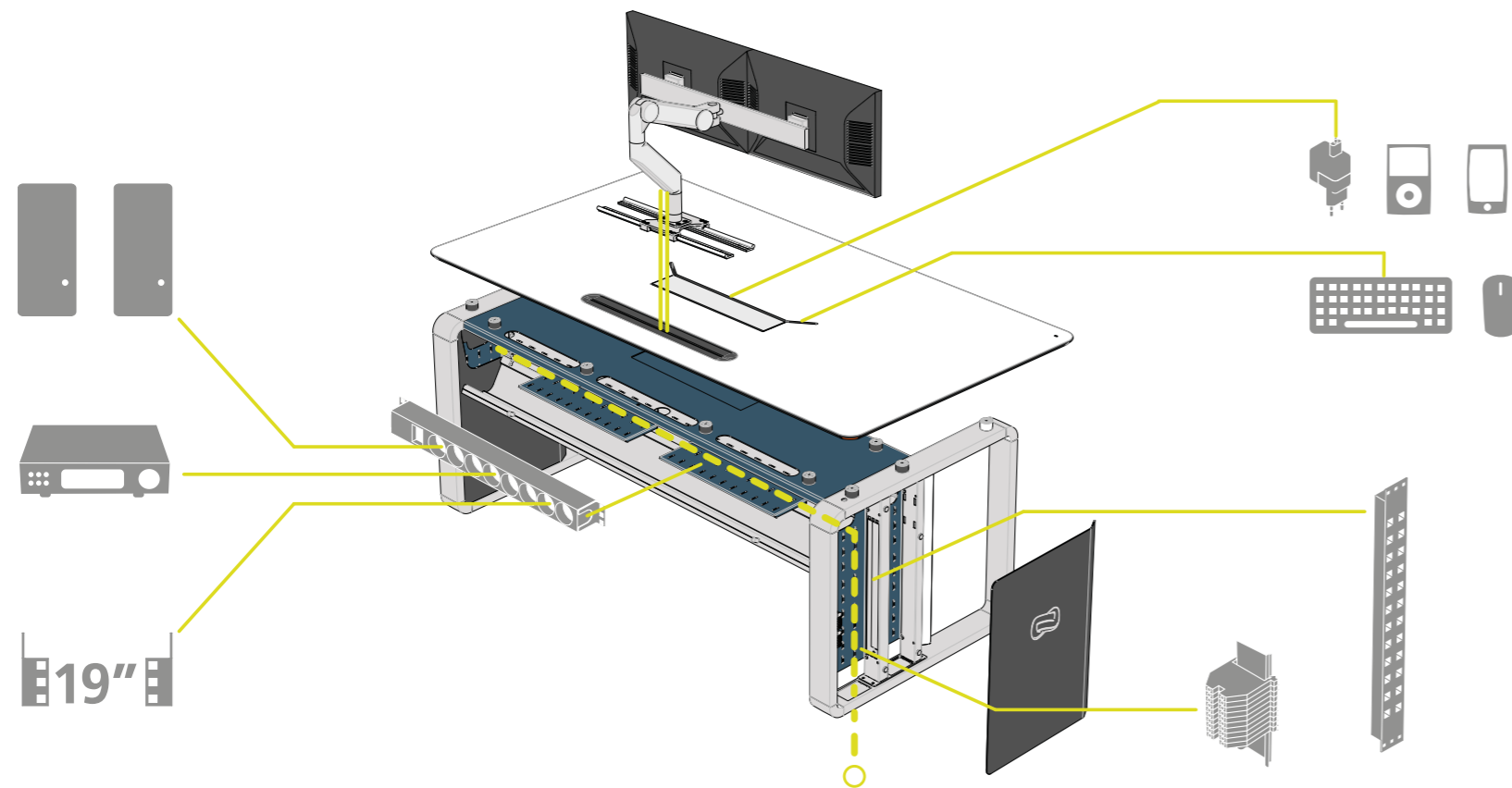



# Integration >

A melting pot of equipments, technologies, ideas and solutions that combine to provide balance, function and safety. No matter what setting or what performance is required, ADVANTIS NG integrates, perfectly, any device required.

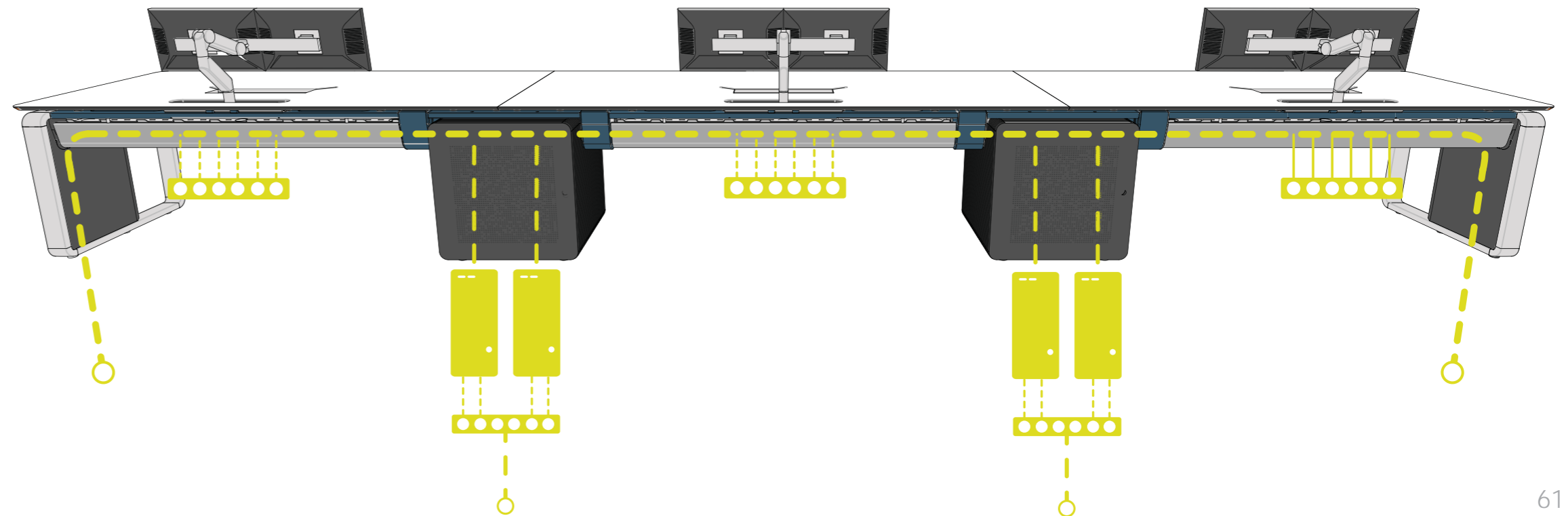

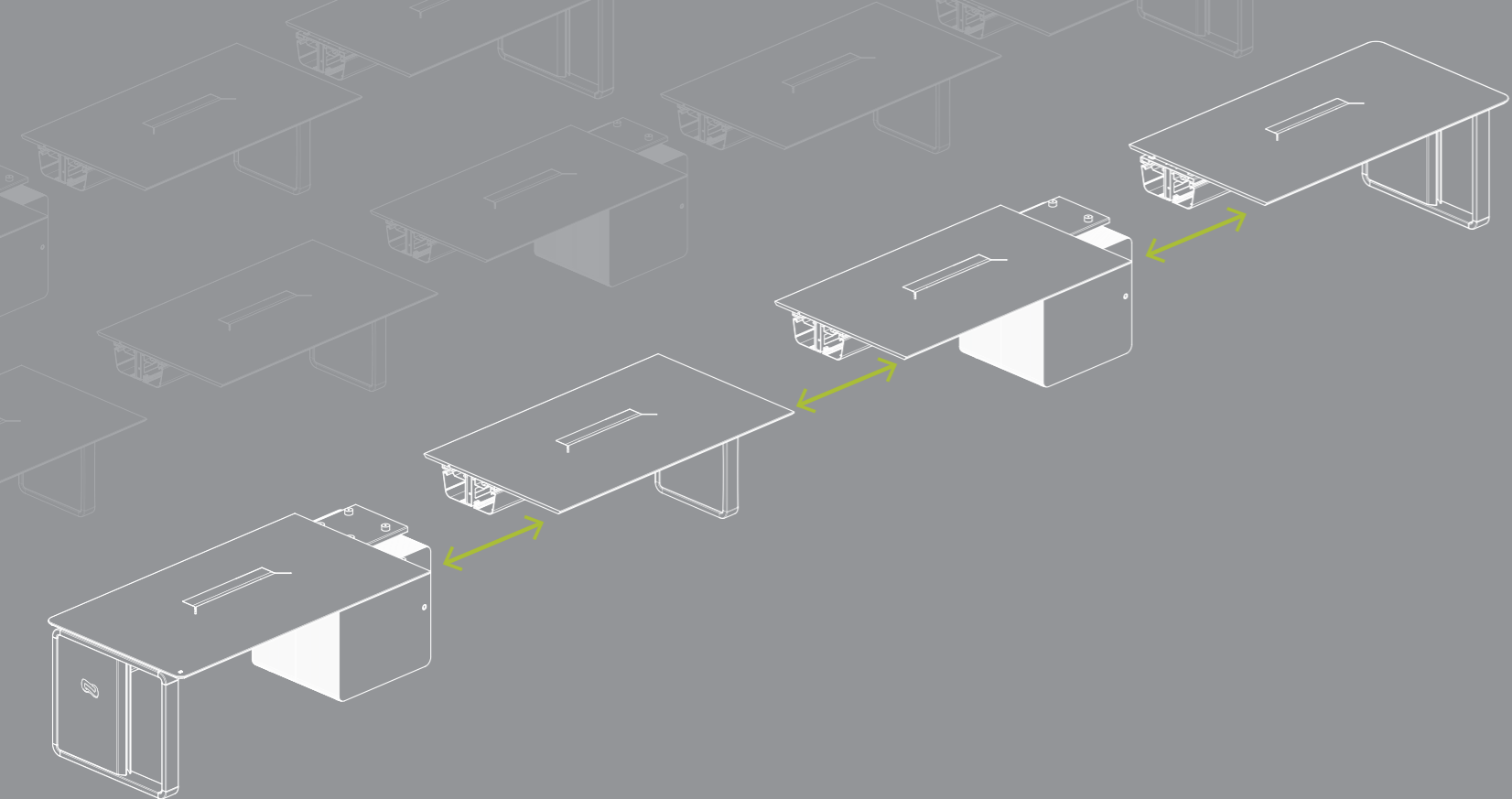

## Modularity >

ADVANTIS NG has been created as a part and as a whole. It may be a single or collective solution, in various forms and quantities: concave, convex, semicircular...

The degrees generator system allows conceiving solutions for any environment and requirement.

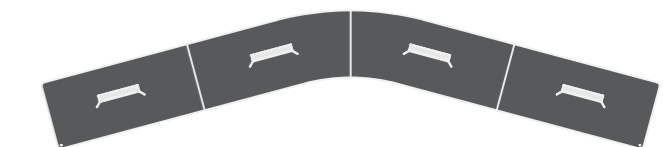
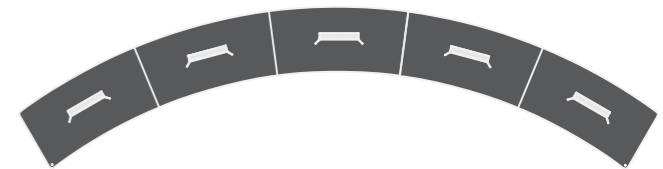
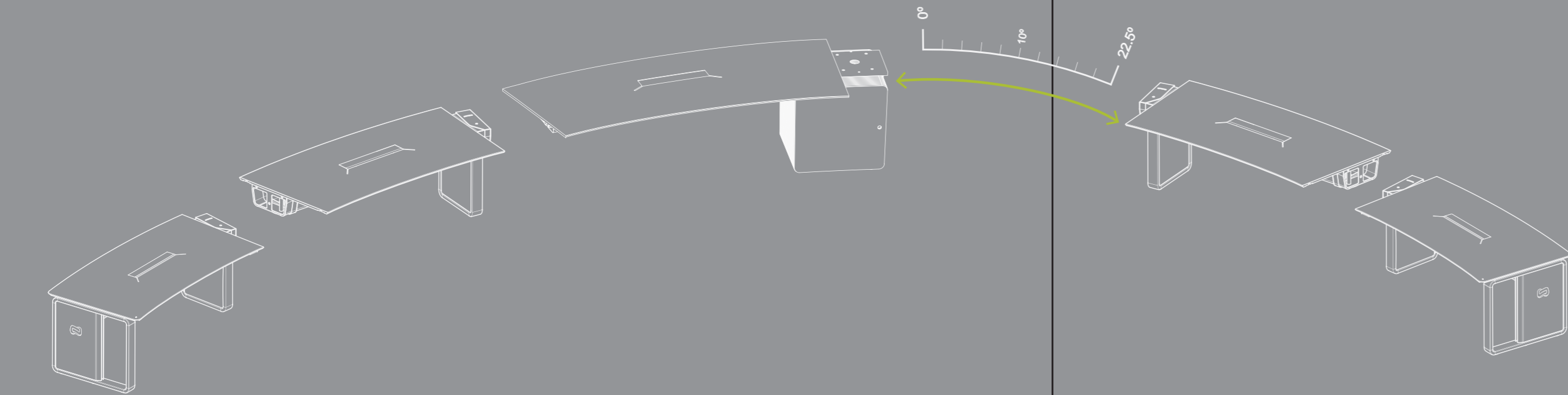



### WI-4D SYSTEM

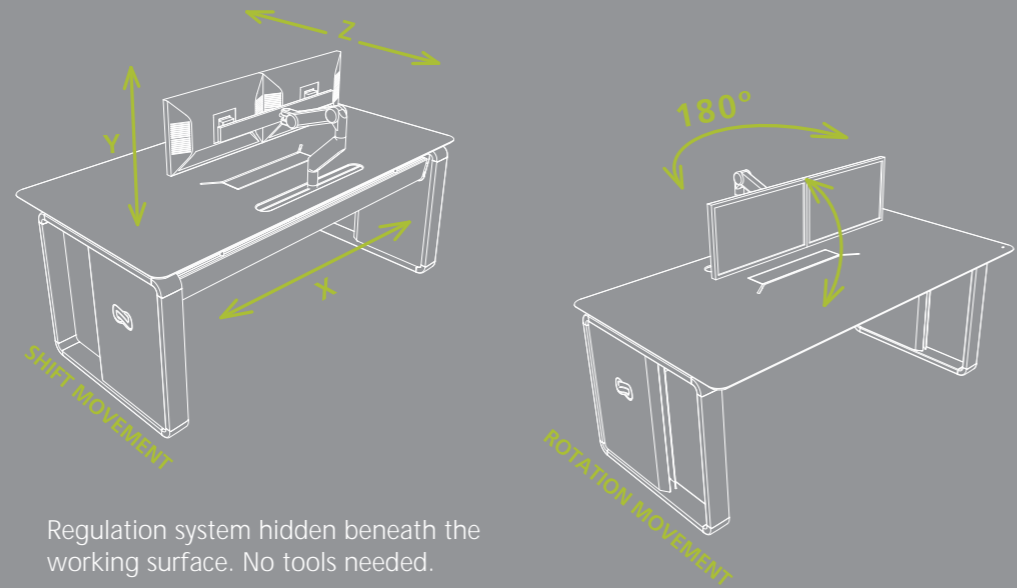

Regulation system hidden beneath the working surface. No tools needed.

### WI-STANDARD SYSTEM

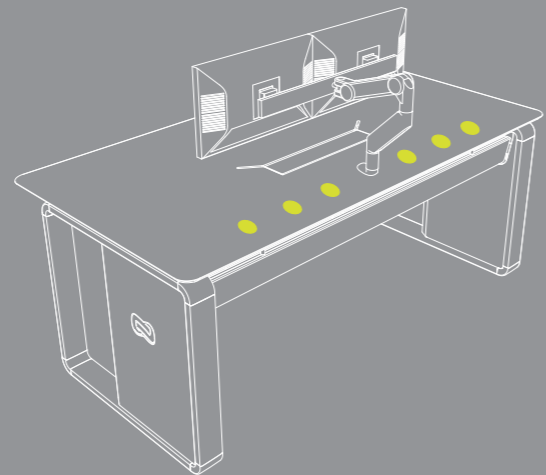
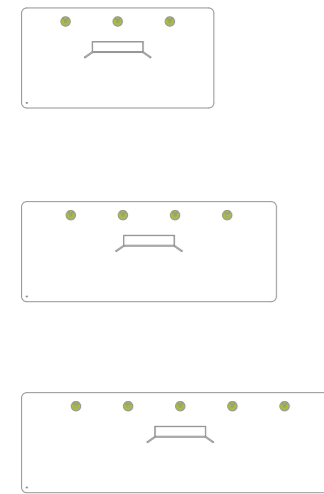

Standard articulated arm system without extended regulation.

### WI-RAIL SYSTEM

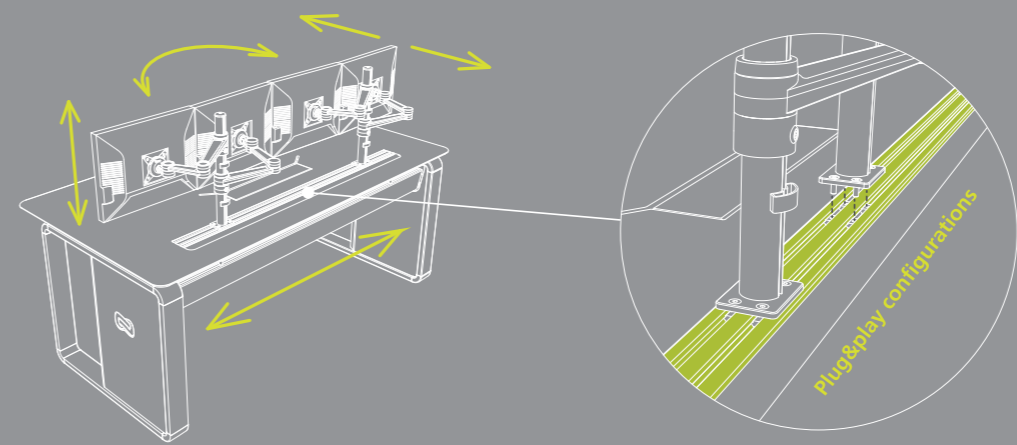





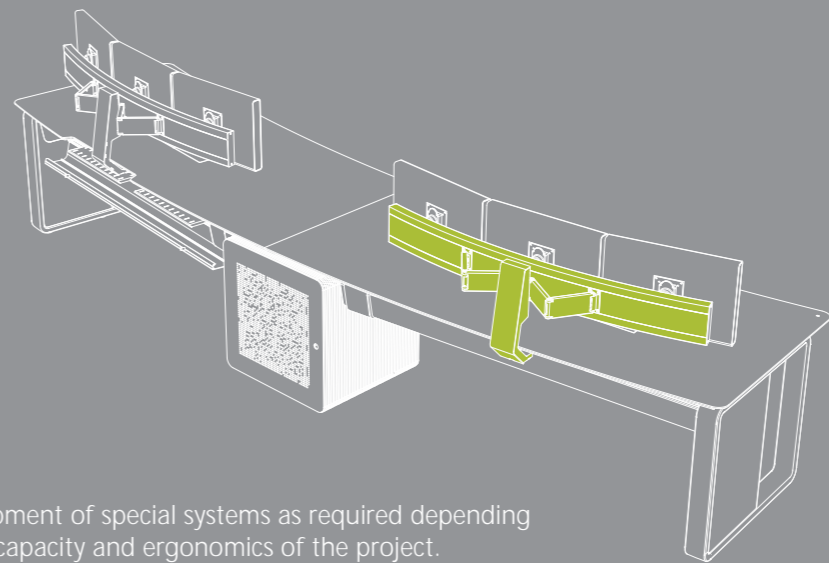

Control system using aluminum lane on the work surface.

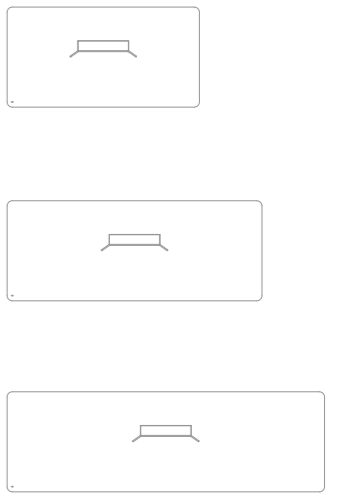
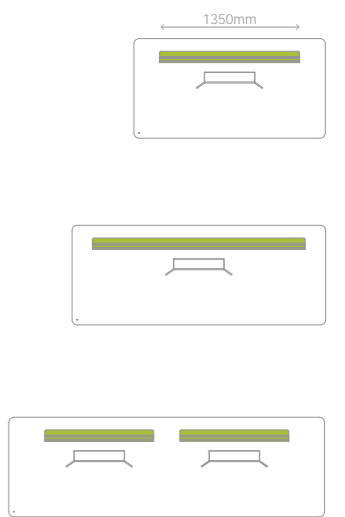

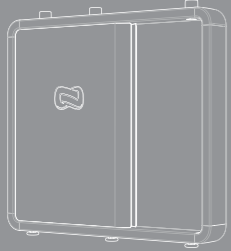
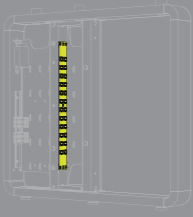
### WI-SPECIAL SYSTEM

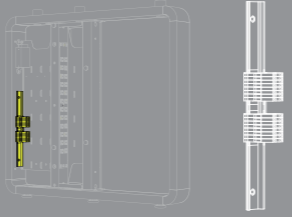





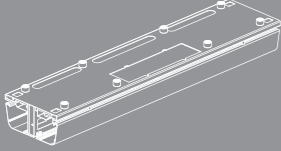
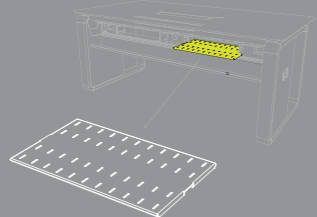
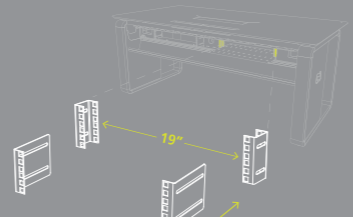

Development of special systems as required depending on the capacity and ergonomics of the project.

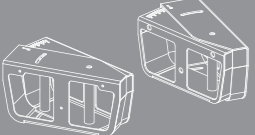
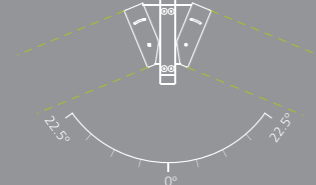
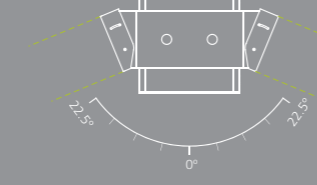



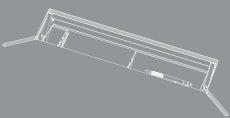
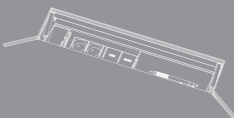



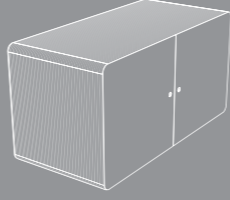
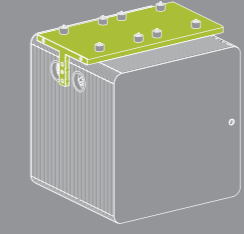
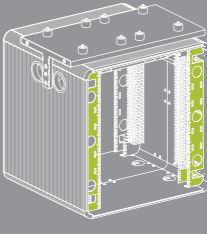

NEXUS GATE	Model	Accessories	Material / Finishes
	Extreme Intermediate Tradding Meetings Sit&Stand Peninsula	 19" panel  Data  IEC  Quick connect terminals	Steel caps  Aluminum profile frame  Steel frame  Steel channeling



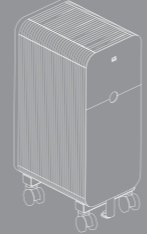
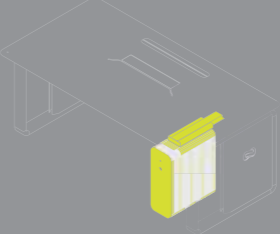
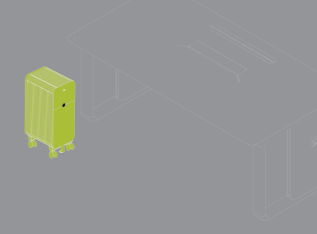

SPINAL BEAM	Model	Accessories	Material / Finishes
	1000mm 1300mm 1600mm 1900mm 2200mm 2500mm 2800mm	 Equipment tray  19" adapter, (Fixed/regulable)	-Aluminium caps  -Steel structure  -Steel trays -19" adapters

ANGLE CREATION SYSTEM	Model	Options	Material / Finishes
	0°-22.5 22.5°-45°	 Nexus Gate creator  Equipments buck creator	-Steel creator structure 

PERSONAL DOCK	Model	Accessories	Material / Finishes
	Standard Meetings Two-sided version	 Basic Personal Dock  ST Personal Dock  HQ Personal Dock	-Nylon components  -Pivoting cover aluminum profile  -Steel tray 

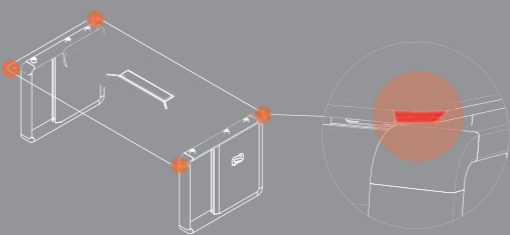
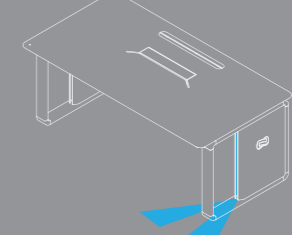
EQUIPMENT BUCK	Model	Accessories	Material / Finishes
	Individual (x1) Double (x2) Triple (x3) Aux. module	 Spinal Beam union support  19" adapter + channeling	-Steel microperforated doors  -Structural aluminum profile  -Steel support  -Steel adapters

i-BOX	Model	Options	Material / Finishes
	200MM 300MM	 Integrated i-BOX  Mobile i-BOX	-Phenolic front  -Structural aluminum profile  -Steel integrator  -Internal steel drawer

SAFETY	Model	Options	Material / Finishes
		 Corner LED safety System  Side lighting floor	-Red light  -White light  -Blue light 

GLOBAL CONCEPT			
			
Advantis NG Sit&Stand	Advantis NG Trading	Advantis NG Supervisor	Advantis NG Meeting

# Contents >

## 15 CONFIGURATION

- 16 The system
- 24 A global concept



## 47 TECHNOLOGY

- 48 Connectivity
- 50 Smart KVM
- 52 Human factor



## 3 PRESENTATION

- 4 Character
- 6 Innovation
- 8 Personality
- 10 Design
- 12 Take Control

## DIFFERENTIAL ELEMENTS 27

- Spinal Beam 28
- Nexus Gate 30
- Floating Operational Area 32
- Visual Ergonomics 34
- Safety 36
- Personal Dock 38
- i-Box 40
- Technical Buck 44

- Ecology 54
- Finishes 56
- Efficiency and effectiveness 58
- Integration 60

## TECHNICAL DATA SHEET 63

- Modularity 62
- Systems 64
- Specs 66



ADVANTIS NG is protected by international patent, community model and property laws Intellectual and copyrights.

GESAB is the owner of these designs, protected by Spanish and international laws. All property rights on any intellectual content of this document were reserved for his exclusive use by GESAB, during all their legal life.

It is understood among those rights, by way of example and not limitation, any property rights intellectual patent records, texts, images, drawings, color combinations, button icons, brands, logos, slogans and designs, as well as on the structure, design, selection, arrangement and presentation of any information and / or contained herein.

It is expressly prohibited, in any case, the reproduction, copying, publication, distribution, modification, deletion, manipulation and any other use, whether or not for profit, all or part of this document or any of its contents, without the prior express by written permission of GESAB.

GESAB reserves the right to modify, change, replace or delete at any time and without notice the contents and information found in this document.

Pictures: GESAB and Antonio Liébana

Design: GESAB

© GESAB, Inc. Copyright 2013. All rights reserved.



**advantis**  
NEW GENERATION

 **Gesab**<sup>®</sup>  
guarantee for the future

**BARCELONA**  
902 113 186  
info@gesab.com  
Avda del Mogent, 68  
08450 Llinars del Valles

**MADRID**  
902 113 187  
info@gesab.com  
Marzo, 61-67  
28022 Madrid

**MÉXICO D.F.**  
+52 55 1997 0746  
infomexico@gesab.com  
Sófocles 127 - Polanco  
Del. Miguel Hidalgo (11540 DF)

**INTERNATIONAL**  
+34 915 345 064  
info@gesab.com  
Marzo, 61-67  
28022 Madrid

[www.gesab.com](http://www.gesab.com)



generation GESAB